





MUSTEE
Preferred by the "Pros"

22C UTILATWIN® Combo Laundry/Utility Tub Everything You Need to Install in One Box!

SEE PAGE 2 FOR A LIST OF ACCESSORIES!



- Molded tubs using Mustee's Co-Polypure™ resin
- Constructed using two Model 12 tubs joined by a molded divider strip
- 15 Gallon capacity, extra deep 13" tub with smooth surface
- Combo-Pack includes everything needed to install the tub...
 1. 6" Swing spout faucet with aerator and hose end 
 2. Two 20" flexible supply lines and sealant tape 
 3. 1-1/2" PVC P-Trap with 12" tailpiece 
 4. Drain Stoppers



- Includes waste connector which joins drain assemblies to assure rapid and uniform waste water discharge...includes washers and slip nuts
- Leakproof, integrally molded-in drain with stopper
- Connects to standard 1-1/2" P or S trap
- Accommodates dual-handle faucet with 4" center
- Includes finished steel legs with adjustable levelers
- Mold and mildew-resistant components
- Easy to assemble and install
- Color-fast white finish

Specifications

Colors & Models:	Model	Mounting	H x W x D	UPC
White	22C	Floor	34" x 36" x 23-1/2"	6 71031 00389 8

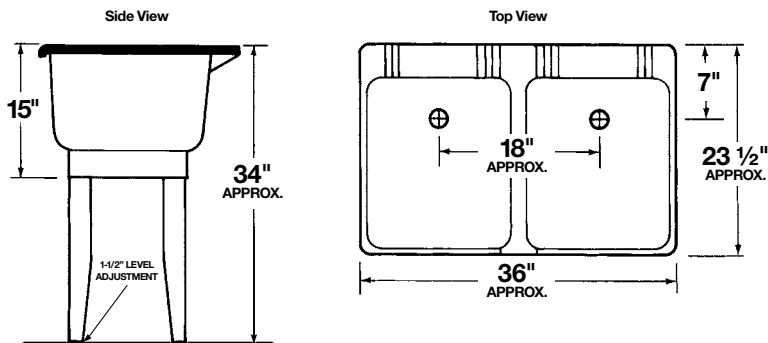

General: Furnish and install as shown on plans, UTILATWIN® Laundry/Utility Tub model 22C, as manufactured by E.L. Mustee & Sons, Inc. Tubs shall be one-piece molded construction using Co-Polypure™ resin with matched metal molds under extreme heat and pressure. Unit shall consist of two tubs joined by molded divider strip and will include a faucet with 6" swing spout, two 20" flexible supply lines and sealant tape, standard 1-1/2" P-trap with 12" tailpiece, twin drain waste coupling, integrally molded drain assembly, stopper and finished steel legs with built-in levelers. 15 gallon capacity tubs, 13" deep. Shall meet ANSI Specification Z 124.6. Color: White. Weight: 24 lbs.



MUSTEE

E.L. Mustee & Sons, Inc. • 5431 West 164th Street • Brook Park, OH 44142 • Phone: 216.267.3100 • Fax: 216.267.9997
E-mail: info@mustee.com • Web: www.mustee.com • Proudly made in the USA

Notice: Our continuous commitment to product improvement may result in changes to product specifications without notice. Patents pending. Made and Printed in U.S.A.



MUSTEE

Preferred by the "Pros"

22C UTILATWIN® Combo Laundry/Utility Tub Accessories

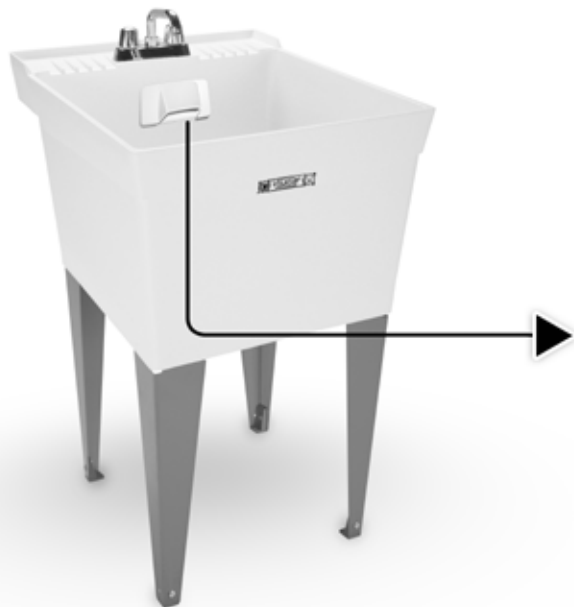

HandiFlo™ Fitting



▶ HandiFlo™ Fitting



Model No.

94.700

UPC

6 71031 00287 7

Dispenses water from washing machine discharge hose into laundry tub. Eliminates draping washer machine hose over back/side wall of laundry tub and conceals discharge hose. Mounts to back or side wall of laundry tub, includes mounting hardware.



MUSTEE

E.L. Mustee & Sons, Inc. • 5431 West 164th Street • Brook Park, OH 44142 • Phone: 216.267.3100 • Fax: 216.267.9997
E-mail: info@mustee.com • Web: www.mustee.com • Proudly made in the USA

Notice: Our continuous commitment to product improvement may result in changes to product specifications without notice.
Patents pending. Made and Printed in U.S.A.